

ZERO

ARB FRIDGE FREEZER



SERVICE MANUAL ZERO

Single Zone Models: 36L (38qrt), 44L (46qrt), 60L (63qrt), 73L (77qrt), 105L (111qrt)

Dual Zone Models: 69L (73qrt), 96L (101qrt)

TABLE OF CONTENTS

1	INTRODUCTION	2
1.1	General information.....	2
1.2	How to use this manual.....	2
1.3	Contact information.....	2
2	WARRANTY	3
2.1	ARB Fridge Freezer Limited Warranty.....	3
2.2	Warranty procedure for service agents.....	3
3	STANDARD SERVICE/WARRANTY TIMES	4
4	SPARE PARTS	5
4.1	Spare parts list.....	5
4.2	Spare parts exploded drawing.....	6
4.3	Minimum stocked spare parts.....	7
5	TOOLS REQUIRED	8
5.1	Basic servicing.....	8
5.2	Servicing the refrigeration system.....	8
6	TROUBLESHOOTING	9
6.1	Check light codes.....	9
6.2	DC Power Supply.....	10
6.3	AC Power Supply.....	14
6.4	Cooling.....	15
6.5	General.....	18
6.6	Battery Protection Settings.....	19
7	FAULT FINDING FLOW CHARTS	20
7.1	Fridge will not run on 100-240V AC power.....	20
7.2	Fridge will not run on 12/24V DC power.....	21
8	CHECKS AND TESTS	22
8.1	Vehicle wiring system.....	22
8.2	Test AC Rectifier.....	25
8.3	Test Compressor control unit – 12/24V DC.....	28
8.4	Test Thermistor.....	30
8.5	Adjust internal temperature correlation.....	31
9	SERVICE AND REPAIR	32
9.1	Handles – Replace.....	32
9.2	Corner Columns – Replace.....	33
9.3	Front Cover – Replace.....	34
9.4	Control Panel Circuit Board – Replace.....	37
9.5	Compressor control unit – Replace.....	38
9.6	Main circuit board - Replace.....	39
9.7	Compressor base plate – Replace.....	41
9.8	AC Rectifier - Replace.....	43
9.9	Cooling Fan - Replace.....	45
9.10	Thermistor – Replace.....	46
9.11	Plug fuse (12/24V DC) - Replace.....	48
9.12	Device fuse (100-240V AC) - Replace.....	48
10	SERVICE BY REFRIGERATION MECHANIC	49
10.1	Compressor recharge information.....	49
10.2	Leaks in the refrigerant system.....	49
11	WIRING	50
11.1	Wiring diagram (Single Zone).....	50
11.2	Wiring diagram (Dual Zone).....	51

1 INTRODUCTION

1.1 General information

This manual is for the sole use of ARB approved repairers and provides information on servicing the ARB Zero Fridge Freezer (Type 10802010 -> 10802070). The part numbers covered by this manual include 10802XYZ, where XY is the specific fridge size and Z is the country destination.

Deviation from the directions given in this manual are not permitted without the express permission of the ARB Fridge Freezer Product Manager or the ARB Warranty Manager.

If you have any queries about servicing an ARB Fridge Freezer, please contact ARB using the contact details below.

This manual makes reference to working with mains power in the range from 100-240V AC. All electrical work of this nature must be carried out by a qualified electrician.

This manual makes reference to working with the refrigeration system of the fridge freezer. All work involving the refrigeration system must be carried out by a qualified refrigeration mechanic.

Please note that safe working practices must be exercised while performing any work on an ARB Fridge Freezer.

1.2 How to use this manual

This manual has been developed as an electronic resource. To navigate through this manual, click on the [blue underlined](#) reference links.

Throughout this manual, reference is made to replacement parts. All spare parts are available from ARB. A complete list of spare parts and corresponding part numbers is given in Section [4.1](#) of this manual. Please note that individual part numbers are not listed elsewhere within this manual.

The following terms are used throughout this manual:

CAUTION: These are instructions given to prevent damage or accidents.

HINT: These are helpful suggestions to aid the servicing procedure.

NOTE: These are details which may further clarify a situation.

WARNING: These are safety warnings. Failure to observe these instructions can cause personal injury or damage to the fridge.

1.3 Contact information

ARB 4x4 ACCESSORIES

Corporate Head Office

42-44 Garden St
Kilsyth, Victoria
AUSTRALIA, 3137

Tel: +61 (3) 9761 6622
Fax: +61 (3) 9761 6807

Australian enquiries
North and South American enquiries
Other international enquiries

sales@arb.com.au
sales@arb.com.au
exports@arb.com.au

www.arb.com.au

2 WARRANTY

2.1 ARB Fridge Freezer Limited Warranty

ARB Corporation Ltd's Fridge Freezers are warranted to be free from material and workmanship defects as per the ARB warranty policy. The below website will direct you to the ARB policies page which contains all current warranty information.

<https://www.arb.com.au/about/policy/>

It is the responsibility of the owner to deliver and pick up the appliance from the place of service.

ARB reserves the right to change the warranty conditions at any time by public notice and by attaching a clear change of warranty terms and conditions notice to the product visible at time of purchase. No party other than ARB Corporation Ltd is authorised to change the terms or conditions of this warranty.

Subject to conditions as defined by the Australian Trade Practices Act 1974 (as amended). There are no other warranties either expressed or implied, which extend beyond those set forth in the preceding paragraphs.

2.2 Warranty procedure for service agents

The following procedure should be followed when processing a warranty claim.

1. The Fridge Freezer should be received with all components, including all power leads. A physical inspection of the unit should be conducted to ascertain whether there is any damage (eg: scratches, dents, stain, etc), and documented on the application.
2. Assess the fridge to identify the fault(s).
3. Complete a copy of the warranty claim form and forward it to your regional ARB Office. To be processed, the form must include the customer's details, serial number, a description of the fault, and the parts required.

NOTE: A copy of the purchase receipt must be submitted with the claim.

4. ARB will assess the claim and if approved will dispatch the required parts as soon as practical at no charge to the repairer. If the claim is not approved, ARB will contact the repairer. ARB will also issue the repairer with a Warranty Claim Number and provide any special instructions for repair or return of faulty parts.
5. The repairer shall replace the specified components as per the service manual and test the ARB Fridge Freezer prior to its return to the customer. It is the responsibility of the repairer to warrant the workmanship of the repair for the minimum period as set out in legislation for the jurisdiction in which the ARB Fridge Freezer has been repaired, or if no period is specified, for a minimum of 90 days.
6. Send an invoice that references the Warranty Claim Number to your regional ARB Office for processing. Any variance to the warranty times as stated in this manual must be approved by ARB.

EXCLUSIONS

Refer to the Warranty Statement supplied with the fridge.

ARB will not accept liability for transport of the ARB Fridge Freezer to or from the service agent.

3 STANDARD SERVICE/WARRANTY TIMES

WORK REQUIRED	INDIVIDUAL WARRANTY TIME*
Compressor – remove and replace **	
Condenser – remove and replace **	
Refrigerant blockage or leak **	
Compressor control unit – remove and replace	1.0 hours
Compressor mounting base –remove and replace	1.5 hours
Control panel circuit board – remove and replace	1.0 hours
Device / plug fuse - replace	0.25 hours
Fan – remove and replace	1.0 hours
Hinge assembly – service	0.25 hours
Inlet power socket - remove and replace	0.75 hours
Latch assembly – remove and replace	0.25 hours
Lid seal – remove and replace	0.25 hours
Interior Light - replace	0.25 hours
Main circuit board – remove and replace	1.0 hours
Power cable – check and replace	0.25 hours
Rubber feet – remove and replace (x 4)	0.25 hours
Thermistor - replace	1.0 hours

* Some warranty times can be negotiable due to unforeseen complexities. Any extension to the standard warranty times must be authorised by ARB.

** These parts are not considered serviceable items. Complete fridge replacement is required.

*** Light LED is only covered under warranty for the first 3 months after the initial purchase date.

ARB will not pay for the removal or replacement of a fridge freezer that has been built in, unless authorisation is given by the ARB.

The warranty labour rate paid will be based on the average refrigeration service rate for the region of the repairer.

Calculating total warranty time

The table above list warranty times for the service of individual components.

If a single item is serviced or replaced and the warranty time is less than 0.5 hours, ARB will accept a total warranty time of 0.5 hours. This will allow for assessment and administration of the warranty claim.

If multiple components are to be serviced or replaced under the same warranty claim, the full individual warranty time will not be paid to replace each component. The total warranty time paid will be calculated as follows:

Individual warranty time	→	<i>For component being replaced with the longest individual warranty time.</i>
+		
0.5 hours	→	<i>For each additional component being replaced with an individual warranty time greater than 0.5 hours</i>
+		
Individual warranty time	→	<i>For each additional component being replaced with an individual warranty time less than 0.5 hours</i>

4 SPARE PARTS

4.1 Spare parts list

The items in the following table correspond with the items on the exploded diagram in section 4.2.

ITEM	ARB MAIN DESCRIPTION	QTY	ARB PART #
1	LID LATCH ZERO 36/44L	1 kit	10910142
2	LID LATCH ZERO 60/69/73/105L	1 kit	10910143
3	LID LATCH ZERO 96L	1 kit	10910144
4	CABINET PIN HINGE ZERO 36/44L	1 pair	10910145
5	CABINET PIN HINGE ZERO 60/69/73/96/105L	1 pair	10910146
6	LID SOCKET HINGE ZERO 36/44L	1 pair	
7	LID SOCKET HINGE ZERO 60/69/73/96/105L	1 pair	
8	CONDENSER FAN ZERO	1	10910159
9	COMPRESSOR CONTROL UNIT ZERO 36/44L	1	10910161
10	COMPRESSOR CONTROL UNIT ZERO 60/69/73/96/105L	1	10910162
11	INTERIOR LIGHT LENSE ZERO	1	10910171
12	CORNER COLUMN ZERO 36L	1 kit	10910172
13	CORNER COLUMN ZERO 44L	1 kit	10910173
14	CORNER COLUMN ZERO 60L	1 kit	10910174
15	CORNER COLUMN ZERO 69/73L	1 kit	10910175
16	CORNER COLUMN ZERO 96/105L	1 kit	10910176
17	LID RUBBER INSERT ZERO 36/44L	1	10910177
18	LID RUBBER INSERT ZERO 60/69/73/96/105L	1	10910178
19	HANDLE ASSEMBLY FRONT ZERO 60/69/73/96/105L	1 kit	10910179
20	HANDLE ASSEMBLY REAR ZERO 60/69/73/96/105L	1 kit	10910180
21	HANDLE ASSEMBLY FRONT ZERO 36/44L	1 kit	10910181
22	HANDLE ASSEMBLY REAR ZERO 36/44L	1 kit	10910182
23	HANDLE SUPPORT BRACKET ZERO 36/44L	1 kit	10910183
24	HANDLE SUPPORT BRACKET ZERO 60/69/73/96/105L	1 kit	10910184
25	RUBBER FOOT ZERO	1	10910185
26	DRAIN PLUG	1	10910186
27	LID ZERO 36/44L	1	10910194
28	LID ZERO 60/69/73L	1	10910195
29	LID ZERO 96LDZ	1	10910196
30	LID ZERO 105L	1	10910197
31	COMPRESSOR BASE SUPPORT ZERO	1	10910202
32	VENT SHROUD SCREWS SIDE ZERO	1 set	10910204
33	VENT SHROUD ZERO 36/44L	1	10910206
34	VENT SHROUD ZERO 60/69/73L	1	10910207
35	VENT SHROUD ZERO 96/105L	1	10910208
36	DISPLAY PANEL TOUCHPAD	1	10910209
37	ARB BADGE LOGO ZERO	1	10910210
38	POWER SOCKET SUPPORT PANEL	1 kit	10910211
39	COMPRESSOR BASE PLATE ZERO 36/44L	1	10910216
40	COMPRESSOR BASE PLATE ZERO 60/69/73L	1	10910217
41	COMPRESSOR BASE PLATE ZERO 96/105L	1	10910218
42	BASKET SYSTEM ZERO 36L	1 system	10910187
43	BASKET SYSTEM ZERO 44L	1 system	10910188
44	BASKET SYSTEM ZERO 60L	1 system	10910189
45	BASKET SYSTEM ZERO 73L	1 system	10910190
46	BASKET SYSTEM ZERO 105L	1 system	10910191
47	BASKET SYSTEM ZERO 69LDZ	1 system	10910192
48	BASKET SYSTEM ZERO 96LDZ	1 system	10910193
49	POWER SOCKET SUPPORT PANEL REAR	1	

NOTES:

- Quantity column indicates maximum number of individual items per service repair.
- The part number given is for singular units unless otherwise stated in the item description.
- Drawings are indicative only, product appearance may change slightly.

4.2 Spare parts exploded drawing

The items in the following exploded diagram correspond with the items in the table in section [4.1](#).

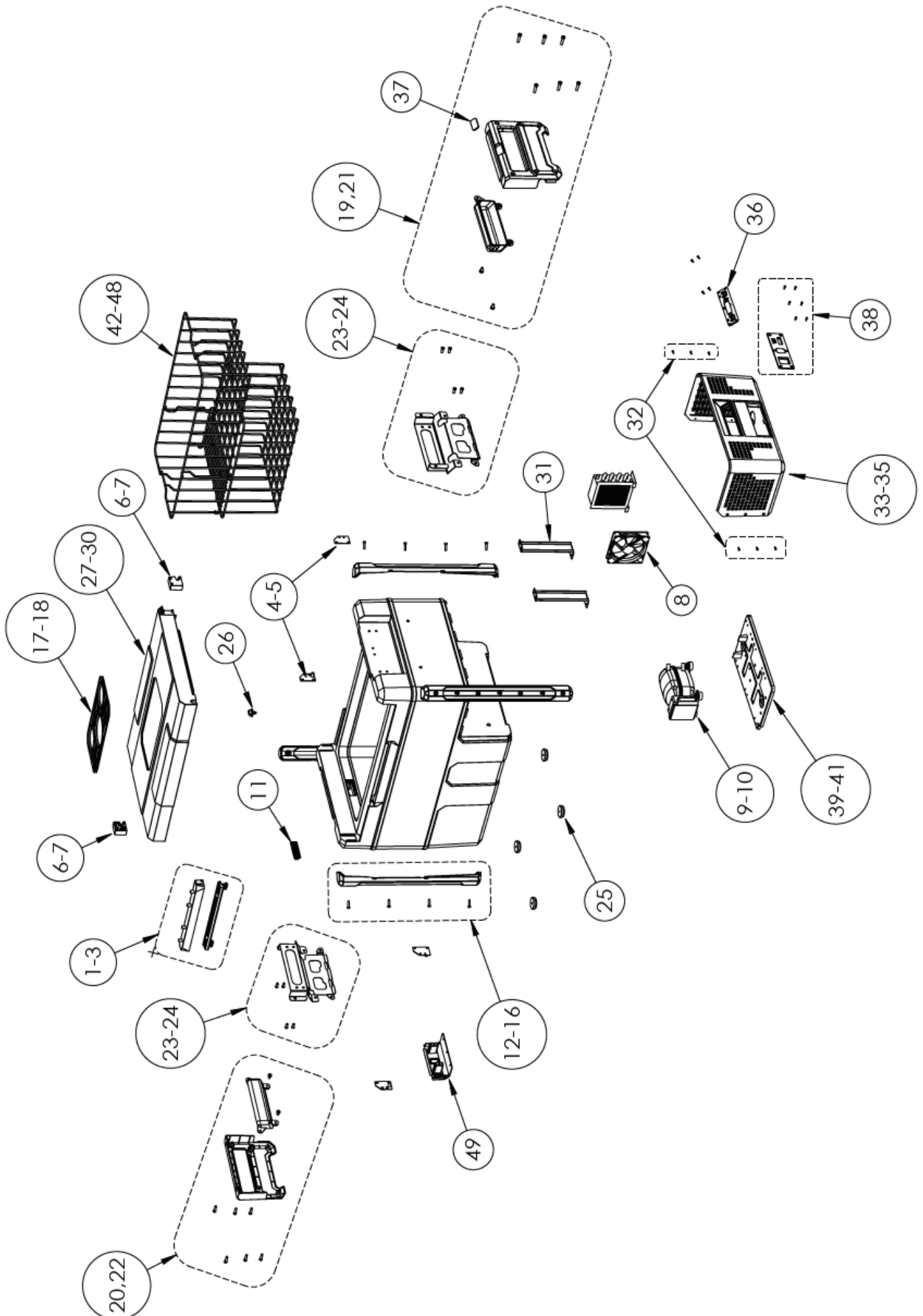

The following items are not illustrated in section [4.2](#).

ITEM	ARB MAIN DESCRIPTION	QTY	ARB PART #
50	AC POWER LEAD ZERO PLUG TYPE I	1	10910163
51	AC POWER LEAD ZERO PLUG TYPE B	1	10910164
52	AC POWER LEAD ZERO PLUG TYPE F	1	10910165
53	AC POWER LEAD ZERO PLUG TYPE D	1	10910166
54	AC POWER LEAD ZERO PLUG TYPE G	1	10910167
55	DC POWER SOCKET ZERO	1	10910168
56	AC POWER SOCKET ZERO	1	10910169
57	DISPLAY PANEL LOOM ZERO	1	10910199
58	TERMINAL COVER CAPS ZERO	1	10910200
59	DC INTERNAL WIRING KIT ZERO	1	10910201
60	BLUETOOTH JUMPER	1	10910203
61	OWNERS MANUAL ZERO AUS/USA	1	10910214
62	COMPRESSOR GROUND WIRE ZERO	1	10910215
63	LID SEAL ZERO 36/44L	1	10910148
64	LID SEAL ZERO 60/69/73L	1	10910149
65	LID SEAL ZERO 105L	1	10910150
66	LID SEAL ZERO 96L	1	10910151
67	POWER SOCKET DECAL ZERO REAR	1	10910152
68	POWER SOCKET DECAL ZERO FRONT	1	10910153
69	DISPLAY PANEL TOUCHPAD DECAL (DUAL ZONE)	1	10910154
70	DISPLAY PANEL TOUCHPAD DECAL (SINGLE ZONE)	1	10910155
71	DISPLAY PANEL PCB ZERO (SINGLE ZONE)	1	10910156
72	DISPLAY PANEL PCB ZERO (DUAL ZONE)	1	10910157
73	MAIN PCB ZERO (SINGLE ZONE)	1	10910158
74	MAIN PCB ZERO (DUAL ZONE)	1	10910219
75	INTERIOR LIGHT PCB ZERO	1	10910170
76	DC SOCKET COVER ZERO	1	10910198
77	VENT SHROUD SCREWS BASE ZERO	1	10910205
78	FRIDGE BASE PLUG ZERO	1	10910212
79	THERMISTER ZERO	1	10910213
80	AC/DC TRANSFORMER ZERO (AC RECTIFIER)	1	10910160

4.3 *Minimum stocked spare parts*

ARB recommends that the following parts be stocked by all ARB fridge freezer service agents. As these parts are consumed, they should be replaced as soon as possible to ensure that all items are on hand when required. For replacement parts, contact your regional ARB office.

Parts not listed in the table below can be ordered from ARB as required.

The item numbers in the table below correspond with the item numbers in the table in section [4.1](#) and the exploded drawing in section [4.2](#).

ITEM	ARB MAIN DESCRIPTION	QTY	ARB PART #
9	COMPRESSOR CONTROL UNIT ZERO 36L/44L		10910161
10	COMPRESSOR CONTROL UNIT ZERO 60L/69L/73L/96L/105L		10910162
73	MAIN PCB ZERO (SINGLE ZONE)		10910158
74	MAIN PCB ZERO (DUAL ZONE)		10910219
8	CONDENSER FAN ZERO		10910159
71	DISPLAY PANEL PCB ZERO (SINGLE ZONE)		10910156
72	DISPLAY PANEL PCB ZERO (DUAL ZONE)		10910157
75	INTERIOR LIGHT PCB ZERO		10910170
11	INTERIOR LIGHT LENSE ZERO		10910171
26	DRAIN PLUG		10910186
	FUSE AC 100-240V 6.3AMP – F6.3L250V		
	FUSE DC GLASS 12/24V 10AMP – 6G10A		
	ARB DC POWER CORD		10910076

5 TOOLS REQUIRED

5.1 Basic servicing

The following tools will be required to perform general non-refrigeration based servicing of the fridge.

Basic tool kit

Phillips head screw drivers (various sizes)

Flat blade screw drivers (various sizes)

Needle nosed pliers

Wire (side) cutters

Vice grips

Sharp knife

Allen key set

Cable ties

12V power supply

Multimeter (with the following ranges)

DC voltage (0 - 24V)

AC voltage (100 - 240V)

Resistance (0.5 Ω – 50 k Ω)

Temperature +10°C (+50°F) to -18°C (0°F)

Jumper cable

Short length of insulated wire terminated with spring loaded clips or push-on connectors at each end.

The following tools will be required to perform specific non-refrigeration based servicing of the fridge

Check vehicle wiring (refer to section 8.1)

DC Voltage Drop tester (available from ARB – part # 10910040)

Replace serviceable thermistor (refer to section 9.10)

Heat transfer paste (available from Jaycar p/n NM-2012)

5.2 Servicing the refrigeration system

It is expected that a refrigeration mechanic who is servicing the refrigeration system will have the appropriate equipment to pressure test, evacuate and charge the system with the specified refrigerant in accordance with local or State handling practices.

6 TROUBLESHOOTING

6.1 Check light codes.

Display “E0” and Check light is solid ON – Temperature sensor issue:

- For temporary use, engage the Emergency Override to operate the fridge freezer.
- Please contact ARB for assistance at your earliest convenience.

Display “E1” and Check light flashes once every 4 seconds – Low supply voltage:

The battery protection system has turned the fridge freezer off because low voltage has been detected.

- Check with a different power source, for example a different vehicle or 240V AC power. If changing the power source fixes the issue, the possible cause could be the original power source.
- Check that the correct battery protection setting has been selected to suit the customer's requirements.
- Check the vehicle wiring is adequate.
 - For cable lengths up to 6m (20'), ARB recommends a minimum automotive cable size of 6 mm (4.5 mm²).
 - For cable lengths greater than 6m (20'), ARB recommends that you consult a qualified technician for advice on the correct wire size.
- Check that all terminals and joints are clean and in good condition.
- Check that the battery voltage at the socket is above the set cut-out voltage (refer to section [6.6](#)). To ensure that voltage drop is accounted for when measuring this voltage, refer to section [8.1](#).

NOTE: The battery protecting system only controls 12 and 24V DC supplies. To confirm that the fridge freezer is operating correctly, connect the fridge freezer to a standard 100-240V AC supply.

Display “E2” and Check light flashes 2 times every 4 seconds – Fan issue:

The control system has turned the fridge freezer off because the fan is drawing more than 0.6 amp while the compressor is running. This could be because the fan is running slowly or not running at all.

- Check that the fan is not obstructed or dirty.

Display “E3” and Check light flashes 3 times every 4 seconds – Compressor start issue:

The compressor will not start because the refrigerant system has become unbalanced. This can occur when the power to the fridge freezer is briefly interrupted.

- Turn the fridge freezer off and disconnect it from its power supply.
- Allow the fridge freezer to stand for 10 to 15 minutes to allow the system to equalise.
- Reconnect the fridge freezer to the power supply and turn it on.
- Compressor control box fault.
- Compressor fault.

Display “E4” and Check light flashes 4 times every 4 seconds – Low motor speed:

The compressor motor is running below its minimum maintainable speed. This could be because the refrigerant system has been overcharged.

Consult a refrigeration mechanic to check that the system is charged with the correct amount of refrigerant.

- Move the unit to a lower ambient temperature.
- Clean vents and ensure clean air flows over the compressor.
- Fan fault.

Display “E5” and Check light flashes 5 times every 4 seconds – Over temperature:

The fridge freezer has stopped operating because the control unit has become too hot.

- Check to ensure that there is adequate ventilation around the control unit and the compressor.
- Check that the fan is operating correctly. The fan must always be running when the compressor is running.
- The fridge freezer may be operating in extremely high ambient temperatures. For example in a sealed stationary vehicle that is parked in the direct sunlight. Try to improve the ventilation around the fridge freezer or shield it from direct sunlight.
- Fan fault.

TROUBLESHOOTING

6.2 DC Power Supply

Symptom	Possible Cause(s)	Suggested Action(s)
Fridge does not run when using a 12/24V DC power supply.	12/24V DC plug fuse has blown.	Replace 12/24V DC plug fuse (refer to section 9.11).
	Fault with 12/24V DC fridge power lead.	Check continuity of lead from plug to socket. Replace lead if faulty or damaged.
	Poor connection of plug to socket in back of fridge.	Check that plug is correctly installed into socket in back of fridge. NOTE: A poor connection can cause high resistance and a large voltage drop. This can cause the battery protection system to activate prematurely.
	No power to supply socket from power source (eg vehicle battery).	Check that vehicle wiring is correct and that power is available at the outlet socket.
	The DC supply voltage is below the minimum voltage needed to operate the fridge.	Connect the fridge to a 12 or 24V DC power supply. Check the supply voltage. NOTE: The compressor control unit and digital display will not operate if the supply voltage is below approximately 7V DC.
	The polarity of the fridge power circuit is wired incorrectly. This means the positive (+) and negative (-) wires are connected back to front.	Check the DC wiring circuit to ensure the polarity (“+” and “-”) is correct. NOTE: The compressor control unit has inbuilt polarity protection and will not function if the polarity is incorrect.
	Poor electrical connection inside the fridge between the power socket and the compressor control unit.	Check connections between the DC socket and the “+” and “-” terminals on the compressor control unit.
		Check that approximately 12 or 24V DC is measured at the “+” and “-” terminals.

TROUBLESHOOTING

DC Power Supply (continued)

<i>Symptom</i>	<i>Possible Cause(s)</i>	<i>Suggested Action(s)</i>
Fridge does not run when using a 12/24V DC power supply.	Faulty compressor control unit.	Test compressor control unit (refer to section 8.3). If compressor does not run during test, replace compressor control unit (refer to section 9.5) and repeat test.
	Faulty control panel circuit board.	Test compressor control unit (refer to section 8.3). If control unit is ok, test fridge with new control panel circuit board and replace if necessary (refer to section 9.4).
	Faulty main circuit board.	Test compressor control unit (refer to section 8.3). If control unit is ok, test fridge with new main circuit board and replace if necessary (refer to section 9.6).
	Faulty thermistor.	Test compressor control unit (refer to section 8.3). If control unit is ok, test fridge with new thermistor and replace if necessary (refer to section 9.10).
	Fault within main wiring loom.	Test continuity of wiring loom from main circuit board to control panel circuit board. If fault identified and unrepairable, contact ARB for advice.
Fridge will not run when DC input voltage exceeds 13.8V (eg When vehicle is running)	Faulty main circuit board.	Replace main circuit board (refer to section 9.6) and retest.

TROUBLESHOOTING

DC Power Supply (continued)

<i>Symptom</i>	<i>Possible Cause(s)</i>	<i>Suggested Action(s)</i>
12/24V DC fridge lead plug fuse blows repeatedly.	Fault within 12/24V DC fridge power lead.	Check continuity of lead from plug to socket. Replace lead if faulty or damaged.
	Incorrect fuse used in plug.	Install the correctly rated fuse. The correct rating is 10Amp (refer section 9.11).
	Short circuit between “+” and “-” terminals on compressor control unit.	Check for short circuits between the “+” and “-” terminals on the compressor control unit.
Compressor stops running, “E1” displayed and Check light flashes twice every 4 seconds.	Compressor has stopped running because battery cut-out voltage has been reached.	Check that correct battery protection setting is selected (refer section 6.6).
		Check that vehicle wiring is adequate. Refer to section 8.1 .
		Check battery voltage and voltage at supply socket. NOTE: Voltage readings must be taken with a load on the circuit to allow for voltage drop within the circuit (refer to section 8.1).
		Check that plug is correctly installed into socket in back of fridge.
		Check that plug is correctly installed into supply socket in vehicle.
		Test fridge on 100-240V AC to confirm correct operation of fridge.
Intermittent power supply to fridge.	Poor connection of plug into socket in back of fridge.	Check that plug is correctly installed into socket in back of fridge.
		Check that the plug makes firm connection with the terminals inside the fridge socket. If fit is loose, test fridge with new power lead. If symptom resolved, replace power lead.
	Poor connection of plug into supply socket (eg vehicle accessories socket).	Check that plug is correctly installed into the supply socket.
	Compressor has stopped running because battery cut-out voltage has been reached.	Check that correct battery protection setting is selected (refer section 6.6).
Check that vehicle wiring is adequate. Refer to section 8.1 .		

TROUBLESHOOTING

DC Power Supply (continued)

<i>Symptom</i>	<i>Possible Cause(s)</i>	<i>Suggested Action(s)</i>
Fridge runs but digital display is not visible.	Faulty control panel circuit board.	Test with new control panel circuit board (refer to section 9.4). If symptom resolved, replace circuit board.
Fridge runs but cannot change target temperature.	Faulty control panel circuit board.	Test with new control panel circuit board (refer to section 9.4). If symptom resolved, replace circuit board.
Fridge does not run, “E2” displayed and Check light flashes twice every 4 seconds.	The fan is not connected to the compressor control unit.	Check the fan wiring to ensure the “+ve” and “-ve” fan wires are correctly connected to the compressor control unit (refer section 9.9).
	Faulty fan.	Test with new cooling fan (refer to section 9.9). If symptom resolved, replace fan. NOTE: The fan must be running whenever the compressor is running.
	Faulty compressor control unit.	Test compressor control unit (refer to section 8.3). If symptom resolved, replace control unit (refer to section 9.5).
Interior cabinet light does not work.	Interior LED is faulty.	Replace LED.
	No power to fridge.	Check that either 12/24V DC or 100-240V AC power is being supplied to the fridge.
	Faulty main circuit board	Test operation of light with new main circuit board. If symptom resolved, replace circuit board.
	Faulty light switch	Replace cabinet assembly.

TROUBLESHOOTING

6.3 AC Power Supply

Symptom	Possible Cause(s)	Suggested Action(s)
No power to fridge when using a 100-240V AC power supply.	Poor connection of plug to back of fridge.	Check that plug is correctly installed into the socket in back of fridge.
	Device fuse in back of fridge cabinet has blown.	Replace device fuse. Refer to section 9.12 .
	No power to supply socket from AC power source.	Check that there is power to the supply socket from the AC power source. NOTE: If using a poor quality power generator, it is possible that the supply voltage could be above or below the 100-240V AC power range and may not be a pure, non-fluctuating sine wave.
	Poor electrical connection inside the fridge between the AC power socket and the compressor control unit.	Check AC electrical wiring within the fridge. NOTE: All AC electrical work should be carried out by a qualified electrician.
	Faulty main circuit board.	Test with new main circuit board. If symptom resolved, replace circuit board (refer to section 9.6).
	Faulty compressor control unit.	Test compressor control unit on AC power (refer section 8.3). Replace if necessary. Test with new compressor control unit. If symptom resolved, replace compressor control unit (refer to section 9.5).
Device AC fuse repeatedly blows.	Short circuit in 100-240V AC fridge cable.	Check continuity of lead from plug to socket. Replace lead if faulty or damaged.
	Short circuit between terminals "L" and "N" on compressor control unit.	Check for short circuit between the "L" and "N" terminals on the compressor control unit.
	Unregulated and/or fluctuating power supply. For example <i>From an engine driven generator.</i>	Ensure that the generator has a voltage regulator and is supplying a standard, pure sine wave AC voltage without fluctuation in voltage or frequency NOTE: Ensure that the fridge is turned off before starting or stopping the generator.
	Fault with compressor control unit.	Test with new compressor control unit & replace if necessary (refer section 9.5).

TROUBLESHOOTING

6.4 Cooling

Symptom	Possible Cause(s)	Suggested Action(s)
Fridge does not cool. Compressor runs.	Poor ventilation.	Check that there is sufficient clearance around the fridge and that the fan is not obstructed.
	Compressor starts and stops because the battery protection system is active. Error light flashes once every 4 seconds.	Check that the correct battery protection setting is selected (refer section 6.6).
		Check that vehicle wiring is adequate (refer to section 8.1).
	NOTE: In the rear of a vehicle, the customer may be unaware that this is occurring.	
	The lid seal is damaged or missing.	Check seal is installed correctly into lid and it is in good condition. Replace seal if damaged or missing.
	Leak in refrigerant system.	Look for visible oil leaks around the refrigeration lines, compressor and condenser. If a leak is detected, contact a qualified refrigeration mechanic for service advice.
If no leak detected, contact a qualified refrigeration mechanic and request that the system is pressure tested.		
Blockage within the refrigeration system.	Contact a qualified refrigeration mechanic for service advice.	
Fridge does not cool. Compressor does not run.	Faulty compressor control unit.	Test compressor control unit (refer to section 8.3) and replace if necessary (refer to section 9.5).
	Faulty control panel circuit board.	Test compressor control unit (refer to section 8.3). If control unit ok, test fridge with new control panel circuit board and replace if necessary (refer section 9.4).
	Faulty main circuit board.	Test compressor control unit (refer to section 8.3). If control unit is ok, test with new main circuit board and replace if necessary (refer to section 9.6).
	Faulty thermistor.	Test compressor control unit (refer to section 8.3). If control unit is ok, test with new thermistor and replace if necessary (refer to section 9.10).

TROUBLESHOOTING

Cooling (continued)

<i>Symptom</i>	<i>Possible Cause(s)</i>	<i>Suggested Action(s)</i>
Temperature display is not accurate with cabinet temperature.	Time lag has not been allowed for.	Allow the fridge to reach the set temperature and cycle a few times before assessing accuracy of temperature. NOTE: A display temperature within 2-3°C (3.6-5.4°F) of the actual temperature at the base of the fridge is within normal on/off cycle temperature variation.
	Frozen items have been placed directly on top of thermistor.	Rearrange items in fridge so that frozen items are not located directly on top of the thermistor. NOTE: The thermistor is located in the base of the fridge directly under the centre of the plastic liner.
	Internal temperature correlation settings inaccurate.	Adjust the internal temperature correlation setting (refer to section 8.5). NOTE: This should not be necessary unless the thermistor has been replaced.
Items freeze with fridge set to warmest setting.	Faulty thermistor.	Test thermistor (refer to section 8.4) and replace if necessary (refer section 9.10).
	Faulty control panel circuit board.	Test fridge with new control panel circuit board and replace if necessary (refer to section 9.4).
	Faulty main circuit board	Test fridge with new main circuit board and replace if necessary (refer to section 9.6).
Fridge does not reach target temperature.	Fridge is operating at its maximum cooling capacity in extreme ambient temperatures.	The maximum cooling capability of the system is a reduction of 50°C (122°F) below ambient temperature. For example <i>In ambient temperatures above 32°C (73°F), the system may not cool to a cabinet temperature of -18°C (0°F).</i>
Large temperature difference between the top and bottom of fridge.	The temperature within the cabinet will vary as the compressor cycles on and off. The temperature difference will vary depending on factors like how the fridge is loaded and how often it is opened.	Advise the customer that some temperature variation is normal within the fridge. NOTE: The temperature difference can increase as the cabinet temperature decreases.

TROUBLESHOOTING

Cooling (continued)

<i>Symptom</i>	<i>Possible Cause(s)</i>	<i>Suggested Action(s)</i>
Fridge cools but compressor runs continuously.	Poor ventilation.	Check that there is sufficient clearance around the fridge and that the fan is not obstructed.
	Fridge is operating at or near the thermal capacity of system.	The thermal capacity of the system is 50°C (122°F) below ambient temperature.
	The lid seal is damaged or missing.	Check that the seal is installed correctly into the lid and that it is in good condition. Replace the seal if it is damaged or missing.
	Faulty thermistor.	Test thermistor (refer to section 8.4) and replace if necessary (refer section 9.10).
	Faulty control panel circuit board.	Test fridge with new control panel circuit board and replace if necessary (refer to section 9.4).
	Faulty main circuit board.	Test fridge with new main circuit board and replace if necessary (refer to section 9.6).
	Insufficient charge of refrigerant in compressor system.	Contact a qualified refrigeration mechanic and request that the system is pressure tested.
	Partial blockage within the refrigeration system.	Contact a qualified refrigeration mechanic for service advice.
Noisy compressor	Compressor is loose or not correctly mounted.	Inspect the compressor to ensure that it is correctly mounted. Replace compressor mounting feet if necessary.
	Noise from inside compressor when fridge experiences high movement and/or vibration.	This noise is normal when the fridge experiences high movement and/or vibration.
	System is low on refrigerant.	Perform checks listed above under "Fridge does not cool. Compressor Runs".
Digital display shows temperature values in the wrong units.	The internal settings within the control panel are incorrect.	Refer to the owner's manual for directions on changing temperature units between °C and °F.

TROUBLESHOOTING

6.5 General

Symptom	Possible Cause(s)	Suggested Action(s)
Latch does not easily disengage from lid.	The seal is causing the lid to sit away from the fridge cabinet.	Press down on the lid slightly to help disengage the latch from the lid.
Noisy fan.	Obstruction in fan.	Remove foreign material from the fan and retest system.
	Faulty fan.	Remove fan from fridge and test. If fan is identified as faulty, replace with new fan (refer to section 9.9).
Lid opens during transit.	The latch was not closed correctly.	Advise customer that latch must be correctly closed before transportation.
	Faulty latch.	Inspect latch and latch pivot for damage.
Lid will not open when fridge is running.	<p>The air inside the fridge has cooled forming a negative pressure within the cabinet.</p> <p>This can occur when the fridge is left running while empty.</p>	<p>Remove the drain plug to allow the pressure inside the cabinet to equalise with the ambient air.</p> <p>Advise customer to remove drain plug from drain if the fridge is to be left running with nothing inside it.</p> <p><i>HINT: Dislodge the drain plug from the fridge cabinet by pushing it up from under the fridge use a small round rod or similar.</i></p>
Hinge noisy during operation.	The hinge sockets have become dirty.	Remove lid from body of fridge. Clean hinge sockets.





TROUBLESHOOTING

6.6 Battery Protection Settings

The ARB Zero Fridge Freezer is fitted with a battery monitor to control the level of discharge of the supply battery. The battery monitor has three settings; HIGH, MEDIUM and LOW. When set to HIGH, the battery monitor will provide maximum protection for the battery against excessive discharging. When set to LOW, the battery monitor will allow maximum use of the energy stored in the battery. The table below shows the voltage cutout levels for the three battery monitor settings.

	LOW (Lo)	MEDIUM (nE)	HIGH (HI)
Switch off voltage – 12V DC	10.1 ± 0.3 V	11.4 ± 0.3 V	11.8 ± 0.3 V
Restart voltage – 12V DC	11.1 ± 0.3 V	12.2 ± 0.3 V	12.6 ± 0.3 V
Switch off voltage – 24V DC	21.5 ± 0.3 V	22.5 ± 0.3 V	23.0 ± 0.3 V
Restart voltage – 24V DC	23.0 ± 0.3 V	24.0 ± 0.3 V	24.5 ± 0.3 V

To change the battery protection level:

- Turn the fridge freezer ON. 
- Press  three times (four times for Dual Zone) to display current battery protection setting.
- Press  or  to change the battery protection voltage between High (HI), Medium (nE) and Low (Lo).
- After 5 to 6 seconds of inactivity, the battery protection voltage will be set and the display will show the current cabinet temperature.

NOTE: *The battery protecting system only controls 12 and 24V DC supplies. To confirm that the fridge freezer is operating correctly, connect the fridge freezer to a standard 100-240V AC supply.*

7 FAULT FINDING FLOW CHARTS

7.1 Fridge will not run on 100-240V AC power

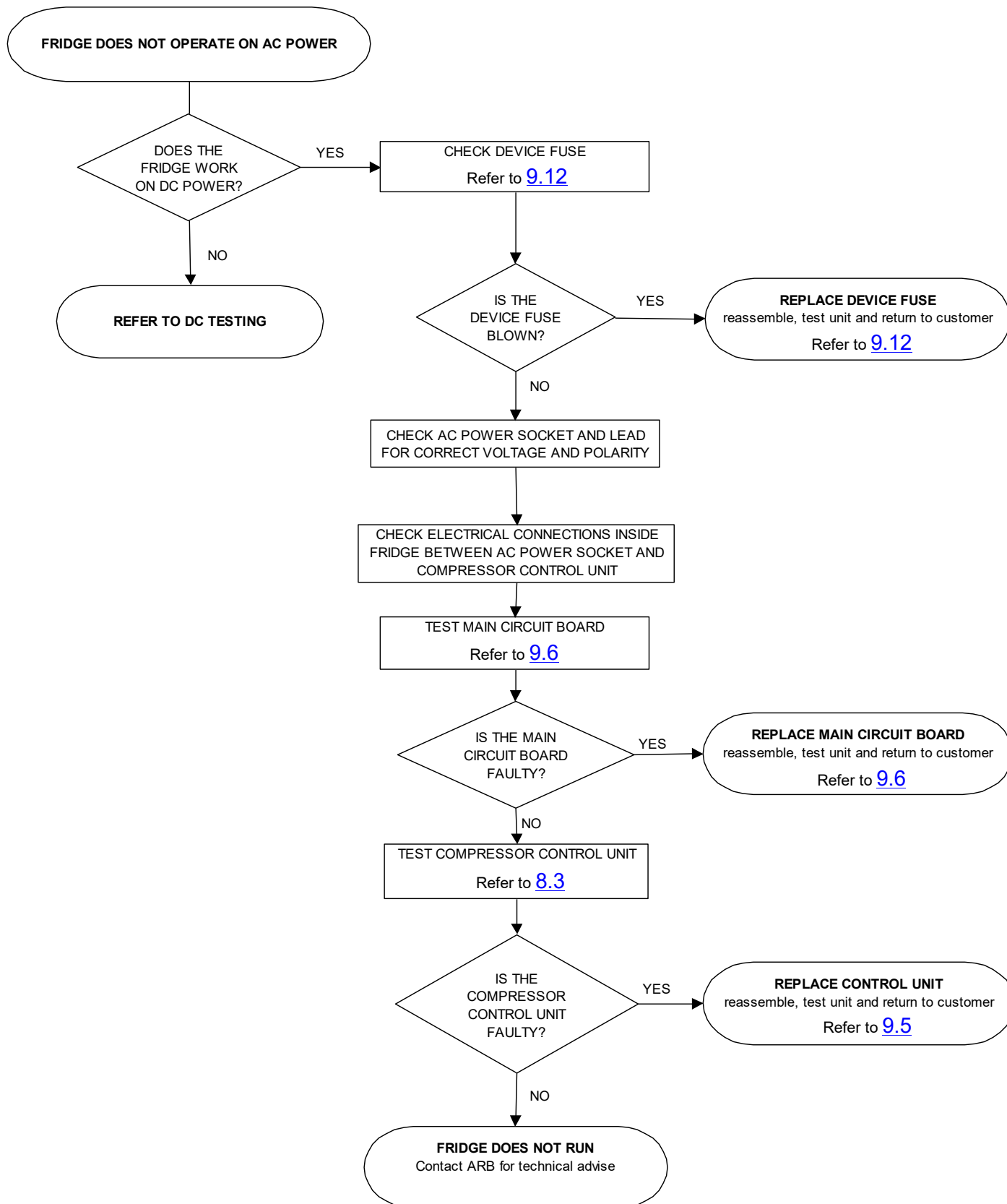

7.2 Fridge will not run on 12/24V DC power

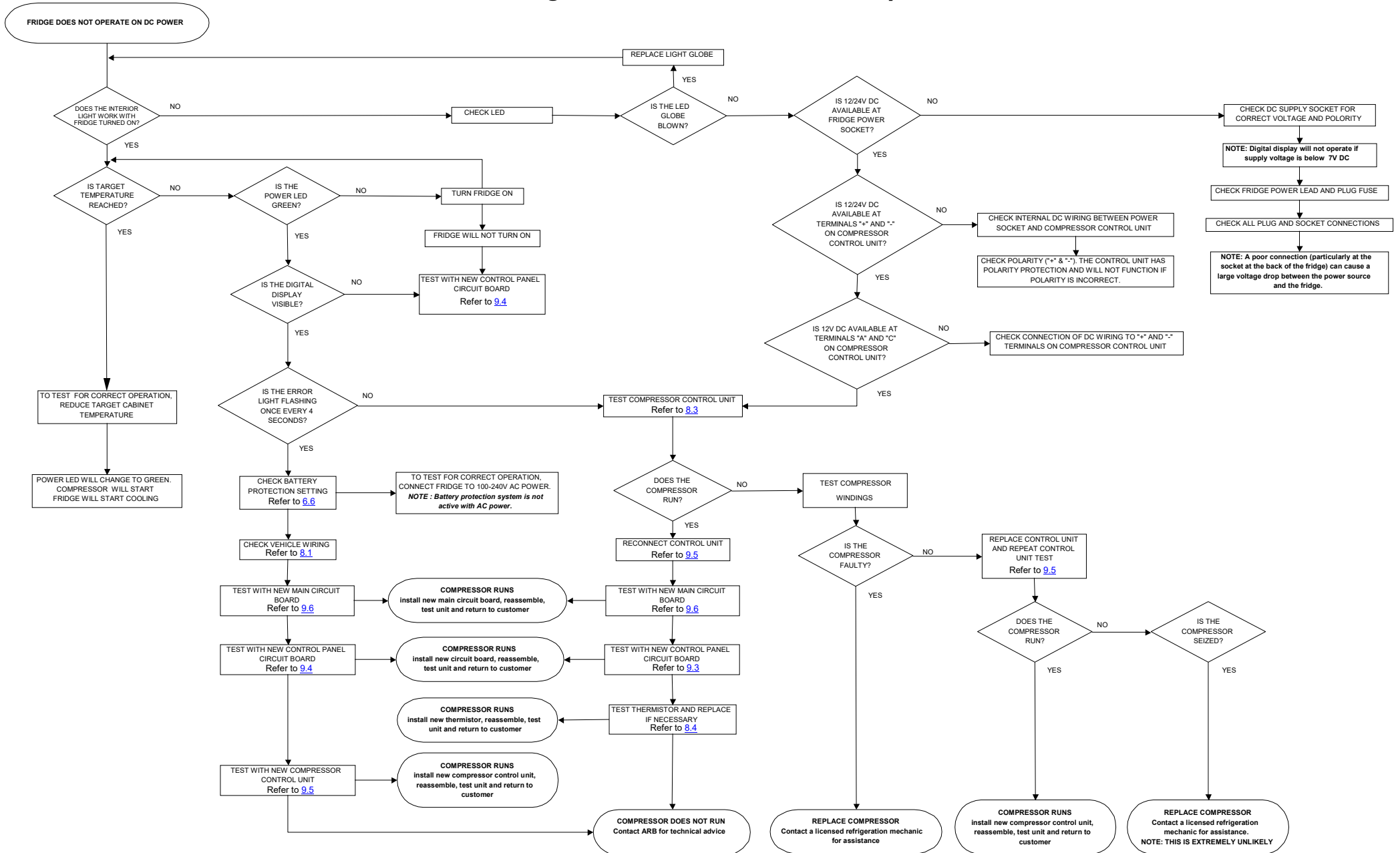

8 CHECKS AND TESTS

8.1 Vehicle wiring system

It is important that the wiring system is capable of carrying the required load to power the fridge freezer. The accessories wiring system in many vehicles is not adequate for such a task. This is particularly true in the rear cargo space of many modern four wheel drives. In some vehicles, these circuits are also connected to the ignition switch and will not supply power if the ignition is turned off.

Measuring the voltage across the battery will not give a true indication of the voltage being supplied to the fridge. Any voltage readings must be taken at the fridge supply socket with the fridge running. This is because any voltage drop caused by losses in the system must be accounted for. Without the fridge running, there will be no load on the circuit and it will not be possible to measure the voltage drop.

Voltage drop is the difference between the voltage readings taken at the fridge supply socket with and without the fridge running. It is calculated using the formula shown below.

$$\begin{array}{l} \text{Voltage drop between} \\ \text{battery and supply} \\ \text{socket} \end{array} = \begin{array}{l} \text{Voltage reading at} \\ \text{supply socket without} \\ \text{fridge running} \end{array} - \begin{array}{l} \text{Voltage reading at supply} \\ \text{socket with fridge running} \end{array}$$

NOTE: In some 12V vehicle wiring systems, the voltage drop between the battery and the rear factory accessories socket can exceed 2V DC.

It is important that the vehicle is not running while these voltage readings are taken. If the vehicle is running, the readings will be the supply voltage from the alternator and not the voltage from the battery.

To check the vehicle wiring system, ARB recommend using a voltage drop tester. The voltage drop tester will simulate the start-up conditions of the Compressor. These voltage drop testers are available from ARB and have been specifically built to simulate the running of an ARB Fridge Freezer (all models).

The procedure for testing a vehicle wiring system using a voltage drop tester is given below. Suggested actions based on the results of the voltage drop test are given at the end of this procedure.

VOLTAGE DROP TEST

Purpose: To test the vehicle wiring system for voltage drop under a simulated fridge freezer load.

Procedure: See below



Turn off the vehicle's engine.

Turn off the vehicle's ignition.

Insert the plug from the voltage drop tester into the fridge/accessories supply socket.

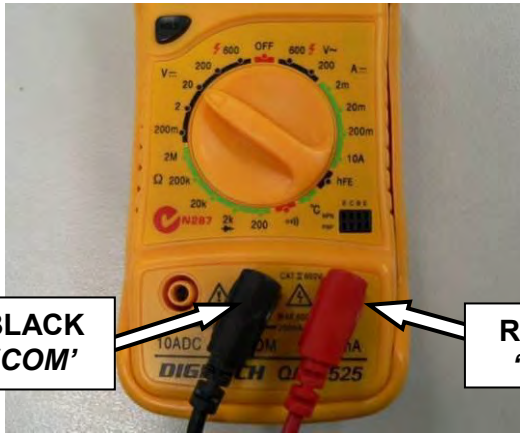

Connect the red lead from the voltage drop tester to the volt ('V') socket on the multimeter.

Connect the black lead from the voltage drop tester to the 'COM' socket on the multimeter.



Record the voltage displayed on the multimeter as '**VOLTAGE A**'.

If no voltage is measured, check whether the circuit is connected to the ignition switch and whether the ignition is turned off.

NOTE: ARB recommend that a dedicated wiring circuit be used to connect the fridge directly to the battery via a suitable fuse. Refer to the wiring advice below.



Press the red button on the voltage drop tester and hold for no longer than 10 seconds.

This will simulate the start-up of the compressor.

With the button pressed down, record the voltage displayed on the multimeter as '**VOLTAGE B**'.



Turn off the multimeter and disconnect the voltage drop tester from the power socket.

Record the voltage across the supply battery terminals as '**VOLTAGE C**'.

Calculate the voltage drop by using the formula below.

$$\text{VOLTAGE DROP} = \text{VOLTAGE 'A'} - \text{VOLTAGE 'B'}$$

If the voltage drop is greater than 0.5 V in a 12V DC system, significant voltage drop is present within the circuit while the fridge is running.

TEST OUTCOMES – VOLTAGE DROP TEST

1. Voltage drop detected

If a significant voltage drop (greater than 0.5 volts for a 12V DC system) is detected, the following checks should be undertaken.

A. Check the size of the wiring used in the circuit.

A dedicated wiring circuit should be installed to power the fridge freezer. This circuit should be as short as practical and should be connected directly to the power supply via a suitable fuse.

- Use a 10 Amp fuse for 12V/24V DC applications.
- For cable lengths up to 6m (20'), use a minimum automotive cable size of 6 mm (approx 4.5 mm²).
- For cable lengths greater than 6m (20'), consult a qualified auto electrician for advice on the correct wire size.
- For best performance, the negative wire of the circuit should be connected directly to the negative terminal of the battery. It should not be grounded directly to the vehicle body or chassis.

B. Check that all terminals and joints are clean and in good condition.

C. Check that the voltage at the supply socket (*VOLTAGE B*) is above the cut-out voltage for the selected battery protection setting (refer to section [6.6](#)).

D. Check that the supply socket is not attached to the vehicle ignition switch. If it is, make sure that the ignition switch is not turned off.

2. Measured voltage below cut-out voltage

If the voltage measured at the supply socket (*VOLTAGE B*) is below the cut-out voltage for the current battery protection setting (refer to section [6.6](#)), the compressor will not run and the error light will flash once every 4 seconds. In this case, the correct battery protection setting should be selected or the supply cable upgraded to 4.5mm² to minimise voltage drop

3. Low voltage detected at both battery and supply socket

If low voltage is detected at both the battery (*VOLTAGE C*) and the supply socket (*VOLTAGE B*), it is recommended that the battery be charged or replaced.

8.2 Test AC Rectifier

WARNING: This test should only be performed by a licensed electrician.

Both the DC power supply and AC power supply are controlled via the AC rectifier unit. If the fridge is not receiving adequate power from the supply source, it is recommended to first eliminate the AC rectifier as the possible cause.

TEST ON AC POWER



Remove the front cover as described in Section [9.3](#).

Plug the AC power plug into the front of fridge and turn the fridge on.

WARNING:
Certain components inside the fridge will be live 100-240VAC. Contact with these components may cause serious injury or death. Please be very careful not to contact or touch any components other than described in this instruction.



Take a multimeter and set the display to DC voltage.

Locate the compressor control unit on the left hand side of the fridge connected to the compressor.

With the multimeter terminals, insert the negative terminal into the black wire at the top "-".

Insert the positive terminal into the red wire, second from the top "+".



The multimeter will display the voltage produced from the AC rectifier. Typically, this voltage should be 24VDC which indicates the AC rectifier is working correctly for AC rectification.

The 12VDC will also need to be checked. Please follow the steps below to complete this test.

TEST ON DC POWER



Remove the front cover as described in Section [9.3](#).

Plug the DC power plug into the front of fridge and turn the fridge on.



Take a multimeter and set the display to DC voltage.

Locate the compressor control unit on the left hand side of the fridge connected to the compressor.

With the multimeter terminals, insert the negative terminal into the black wire at the top “-”.

Insert the positive terminal into the red wire, second from the top “+”.



The multimeter will display the voltage from the AC rectifier. Typically, the measured voltage should equal the supply voltage which indicates the AC rectifier is working correctly for DC supply.

The example shown, the supply voltage was 12VDC, and the multimeter measures 12.46V. If the supply voltage was 24VDC, the multimeter would measure 24V.

TEST OUTCOMES

The measured voltage is very low (almost 0VDC) when AC or DC power is supplied.

- A. Remove the AC power source from the fridge. Check that the fridge internal wires, terminals and joints are clean and in good condition.
- B. Check that the AC power source is working correctly. To complete this safely, we recommending trying the power source on another fridge or electrical appliance.
- C. After completing a comprehensive check on all other potential causes, the AC rectifier may be the cause and should be replaced.

The measured DC voltage is considerably less than the supply voltage.

- A. Remove the DC power source from the fridge. Check that the fridge internal wires, terminals and joints are clean and in good condition.
- B. Check the voltage loss from the power source to the fridge socket is insignificant. Please note, the voltage measured at the fridge socket should equal the voltage measured at the compressor control unit.
- C. After completing a comprehensive check on all other potential causes, the AC rectifier may be the cause and should be replaced.

8.3 Test Compressor control unit – 12/24V DC

WARNING: This test should only be performed by a licensed electrician.

Purpose: To verify the correct operation of the compressor control unit on 12/24V DC.

Approach: This test will isolate the compressor control unit from the remaining fridge electronics including the main circuit board, control panel circuit board, thermistor and wiring loom.

Test pass: The compressor runs. In this case the main circuit board, control panel circuit board, thermistor or wiring loom are possibly faulty.

Test fail: The compressor does not run. In this case the compressor control unit is likely to be faulty. It is also possible that the compressor could be faulty but this is extremely unlikely.

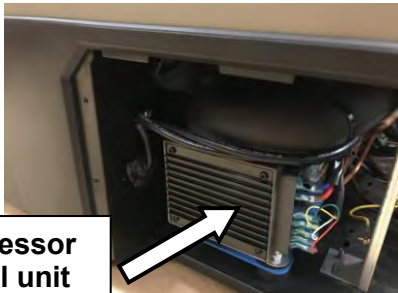
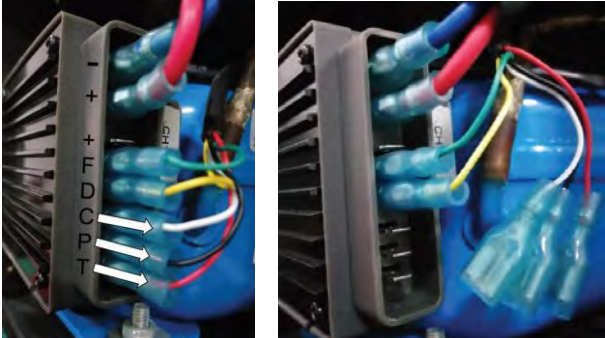
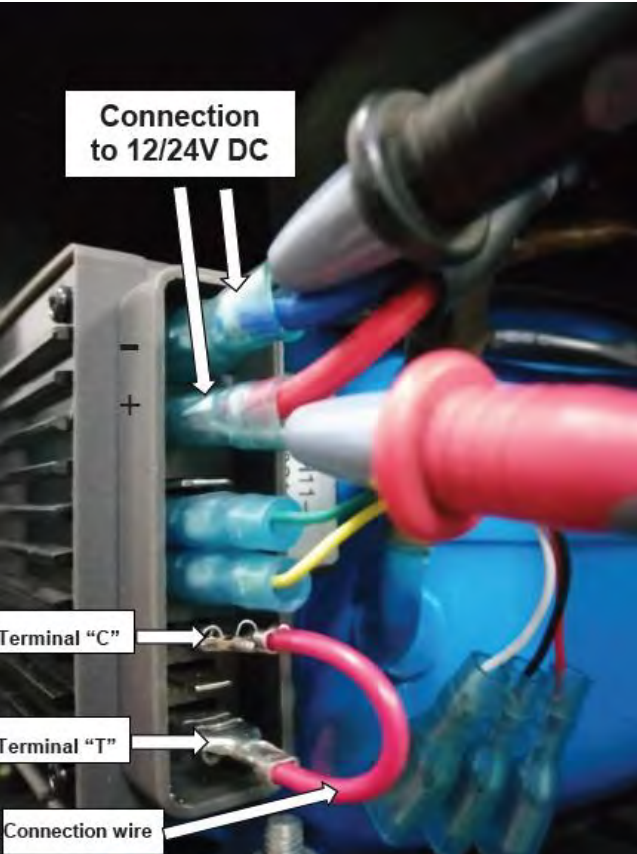
 <p>Compressor control unit</p>	<p>Disconnect all power leads from the back of the fridge.</p> <p>Remove the front cover (refer to section 9.3).</p> <p>Identify the compressor control unit.</p>
	<p>Disconnect the push on connectors from terminals "T", "P" and "C".</p>
	<p>Apply 12 or 24V DC to terminals "+" and "-" on the compressor control unit. ARB recommends that the supply voltage be applied through the DC power socket in the back of the fridge and not directly to the compressor control unit.</p> <p>Use a DC voltmeter and confirm the polarity of the 12 or 24V DC supply voltage across terminals "+" and "-" is correct.</p> <p>Connect between terminals "T" and "C" using a short length of wire as shown.</p> <p>NOTE: The compressor control unit has polarity protection and will not work if the polarity is incorrect.</p> <p>NOTE: The compressor control unit and digital display will not operate if the supply voltage is below approximately 7VDC.</p> <p>NOTE: The connecting wire should be terminated with either push-on connectors or spring loaded clips suitable for good contact with the terminals.</p>

TEST PASS – COMPRESSOR RUNS

With terminals “T” and “C” connected, the compressor should start running and the system should start cooling. In this case, the compressor control unit is functioning correctly. The compressor control unit has now been eliminated as a possible fault.

The next step is to investigate a fault in the main circuit board, the control panel circuit board, the thermistor or the wiring loom.

Before continuing, disconnect the fridge from the 12/24V DC power supply, remove the connecting wire and refit the push on connectors to terminals “C”, “P” and “T”.

NOTE: During this test, the compressor should draw approximately 3 amps or greater depending on the fridge model size.

NOTE: There may be a delay of approximately 10 seconds after connecting terminals “T” and “C” before the compressor starts.

TEST FAIL – COMPRESSOR DOES NOT RUN

With terminals “T” and “C” connected, the compressor does not start. In this case, either the compressor or the compressor control unit are likely to be faulty.

Replace the control unit (refer to section [9.5](#)) and repeat the compressor control unit test.

If the compressor does not run with a new compressor control unit, the compressor may be seized. While it is possible for the compressor to be seized, it is EXTREMELY unlikely.

8.4 Test Thermistor

Purpose: To verify that the thermistor is operating correctly.

Single Zone main circuit board.

Thermistor Socket



Dual Zone main circuit board.

Thermistor Socket Front Zone Thermistor Socket Rear Zone



Disconnect all power leads from the back of the fridge.

Remove main circuit board (refer to section [9.6](#)).

Locate and disconnect the 2 pin male thermistor plug on the main circuit board.

Please note, for Dual zone fridges, there are two thermistors, please ensure you test both thermistor.

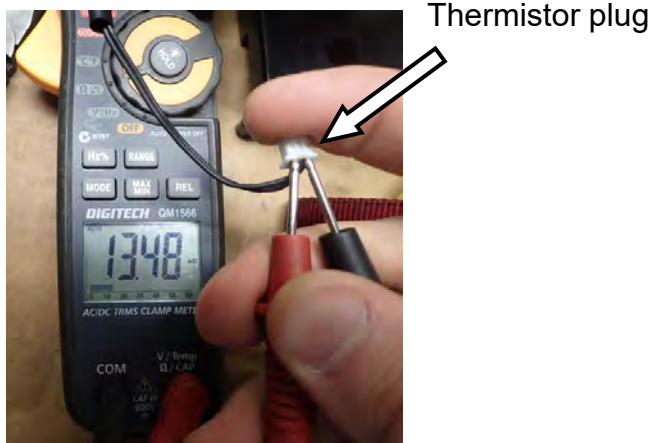

Using an ohm meter (Ω), measure the resistance value of the thermistor.

To do this, measure the resistance between the two metal contacts in the plastic connector plug as shown.

NOTE: The resistance of the thermistor will increase as the fridge gets colder.

Measure the temperature of the plastic liner at the base of the fridge.

Thermistor resistance values

Temperature of plastic liner at base of fridge	Resistance Value
10°C (50°F)	18k Ω
5°C (41°F)	22k Ω
0°C (32°F)	28k Ω
-5°C (23°F)	34k Ω
-10°C (14°F)	43k Ω

NOTE: At approximately 20°C (68°F) degrees, the thermistor should read between 8-14k Ω .

Check the measured resistance against the resistance values in the table for the given temperature.

NOTE: Allow a variation of $\pm 5k \Omega$ between the measured resistance and the values in the table.

TEST PASS

If the measured resistance is within $\pm 5k \Omega$ of the tabulated value, the thermistor is functioning correctly.

TEST FAIL

If the measured resistance varies greatly from the tabulated value or an open circuit is detected, the thermistor is faulty and should be replaced (refer to section [9.10](#)).







8.5 Adjust internal temperature correlation

Purpose: To adjust the internal temperature calibration so that the display temperature matches the temperature at the base of the fridge.

This adjustment should only be necessary if the thermistor has been replaced.

NOTE : *A display temperature within 2-3°C (3.6-5.4°F) of the actual temperature at the base of the fridge is within normal on/off cycle temperature variation. If this is the case, the internal temperature calibration should not be changed.*

Procedure:

- Connect the fridge to 12/24V DC or 100-240V AC.
- Turn the fridge on.
- Press and hold  and  simultaneously until "A 0" appears on the display.
- Push  or  to adjust the setting.
- Continue pressing  or  until the desired adjustment is made.
- After 5 to 6 seconds of inactivity, the display will flash twice and return to displaying the current target temperature.
- Allow the fridge to cycle on and off a few times to allow for any temperature lag.
- Check the temperature display against the temperature at the base of the cabinet.

CALIBRATION SUCCESSFUL





If the temperature display is within 2-3 °C (3.6-5.4°F) of the temperature at the base of the fridge, return the unit to the customer and advise that this is within normal on/off cycle temperature variation.

REPEAT CALIBRATION

If the temperature display is not within 2-3 °C (3.6-5.4°F) of the temperature at the base of the fridge, repeat the calibration procedure above.

9 SERVICE AND REPAIR

9.1 Handles – Replace

 <p>A diagram of the Zero 1000 power station showing the handle assembly. Six white arrows point to the fasteners securing the handle assembly: three on the left side and three on the right side.</p>	<p>With Allen key, remove all six fasteners securing the handle assembly.</p>
 <p>A photograph of the Zero 1000 power station with the plastic handle assembly removed. The metal handle support bracket remains attached to the top of the unit.</p>	<p>Remove the plastic handle assembly.</p>
 <p>A close-up photograph showing a hand using a blue Allen key to remove a fastener from the metal handle support bracket.</p>	<p>With Allen key, remove all four fasteners securing the handle support bracket.</p>
 <p>A photograph of the Zero 1000 power station with the handle support bracket removed. The top surface of the unit is now flat.</p>	<p>Remove the handle support bracket.</p>

9.2 Corner Columns – Replace



With Allen key, remove all four fasteners from the column.



The column should fall off the fridge and remove easily.

To refit corner columns



To refit column, align column on corner of fridge.

Hold firm in position and install the top fastener and tighten loosely.

Insert the remaining three fasteners loosely and check column position and alignment.

If satisfied, tight all four fasteners, be careful not to over tighten fasteners.

9.3 Front Cover – Replace

To remove front cover



Disconnect all power leads from the back of the fridge.

Remove the two rear columns secured to the front cover as described in Section [9.2](#).



Remove the side screws from the front cover.

There are three screws on each side of the front cover.



Remove the base screws from the front cover.

There are twelve (12) screws to remove.



The rear cover can be flipped back to access various systems of the fridge.

If the front cover does not need replacing, you may not need to continue through the remaining steps.

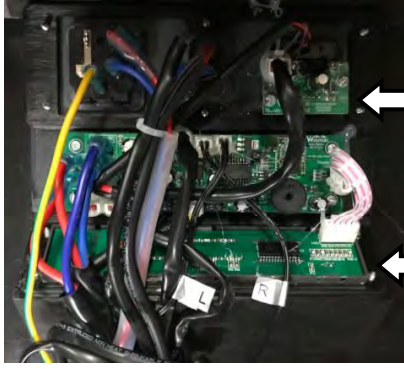

Power supply panel

Touchpad panel

Remove all wires connected to the power supply panel and the touchpad panel.

Take note of where the wires connect to these circuit boards.



To remove the power supply panel, first peel back the decal with thin blade.

This will allow access to four screws securing the power supply panel. Remove four screws, and pull the power supply panel from the front cover.



To remove the touchpad panel, first peel back the decal with thin blade.

This will allow access to four screws securing the touchpad panel. Remove four screws, and pull the touchpad panel from the front cover.



Main circuit board

Remove the four screws securing the main circuit board from the front cover.

Remove the main circuit board from the front cover.

The front cover is now disconnected from the fridge cabinet and can be removed.

To refit front cover



Refitting the front cover is reversal of the removal process.

Refit the touchpad panel and power supply panel.

Refit the decals for the touchpad and power supply.

Insert all wire terminals into their correct position.

Flip the front cover back over the fridge cabinet as shown. Fasten the front cover to the body of the fridge using all screws.

Refit the corner columns as described in Section [9.2](#).

CAUTION: When refitting cover, ensure that all cables are securely fastened away from sharp, moving or hot surfaces.

9.4 Control Panel Circuit Board – Replace.

The touch pad decal is an integral sealing component used to reduce water ingress around the electronic control panel. The touch pad is a single use item only. ARB recommends removing and replacing a damaged touch pad to maintain sealing integrity.



The control panel circuit board can be removed from the front cover without removing the front cover.

With thin blade, remove the corners of the touchpad decal to gain access to the screws behind the decal.



With screw driver, remove the four retaining screws from the touchpad support panel.



Remove the touchpad support panel from the front cover. You may need to pry out the touchpad from its location.

Remove wire plug from the touchpad PCB.







Remove the control panel circuit board from the touchpad support panel.

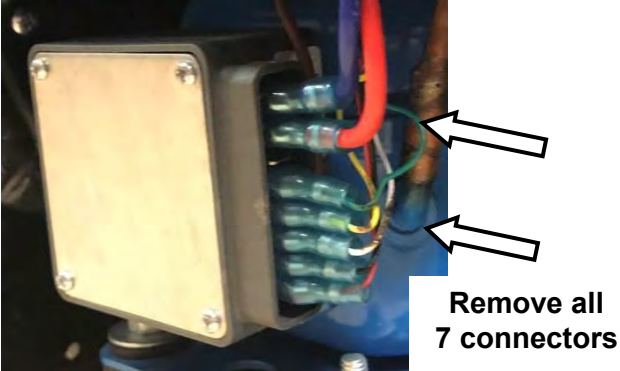
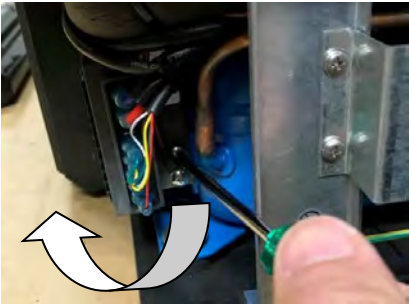

Replace control panel circuit board in touchpad support panel and reassembly the touchpad into the front cover.

Check all touchpad buttons and display and operating correctly.

9.5 Compressor control unit – Replace

	<p>Disconnect all power leads from the back of the fridge.</p> <p>Remove the front cover as described in Section 9.3.</p> <p>It is not necessary to remove all circuit boards as described in Section 9.3.</p>																	
	<p>Locate the compressor control unit mount on the compressor.</p> <p>Disconnect all seven (7) connectors from compressor control unit.</p> <p>HINT: Use a pair of pliers to help release the connectors from the compressor unit terminals.</p>																	
	<p>Remove two mounting screws securing the compressor control unit to the side of the compressor.</p> <p>Pull the compressor control unit away from the compressor as per the arrow shown.</p>																	
	<p>Remove the three pin plug from the side of the compressor.</p> <p>The compressor control unit can now be removed</p>																	
<table border="0"> <tr> <td>-</td> <td>BLUE</td> <td rowspan="10">  </td> </tr> <tr> <td>+</td> <td>RED</td> </tr> <tr> <td>+</td> <td>GREEN</td> </tr> <tr> <td>F</td> <td>YELLOW</td> </tr> <tr> <td>D</td> <td>WHITE</td> </tr> <tr> <td>C</td> <td>BLACK</td> </tr> <tr> <td>P</td> <td>BLACK</td> </tr> <tr> <td>T</td> <td>RED</td> </tr> </table>	-	BLUE		+	RED	+	GREEN	F	YELLOW	D	WHITE	C	BLACK	P	BLACK	T	RED	<p>Installation is the reverse procedure.</p> <p>Please note, connect the seven connectors to the new control unit in the correct order.</p> <p>Refit the rear cover.</p> <p>Restore power to fridge and check for correct operation.</p> <p>CAUTION: Ensure that all cables are securely fastened away from sharp, moving or hot surfaces.</p>
-	BLUE																	
+	RED																	
+	GREEN																	
F	YELLOW																	
D	WHITE																	
C	BLACK																	
P	BLACK																	
T	RED																	

9.6 Main circuit board - Replace



Disconnect all power leads from the back of the fridge.

Remove the front cover as described in Section [9.3](#).

It is not necessary to remove all circuit boards as described in Section [9.3](#).

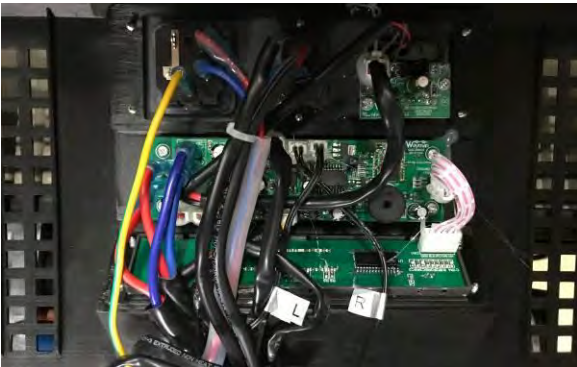

Locate the main circuit board and disconnect all connectors from the main circuit board.

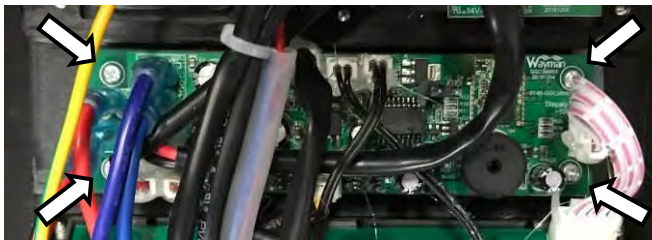

Remove the four retaining screws securing the main circuit board to the front cover.

The main circuit board can now be removed from the fridge.

Installation is the reverse procedure.

Refit the rear cover.

Restore power to fridge and check for correct operation.

CAUTION: Ensure that all cables are securely fastened away from sharp, moving or hot surfaces.

MAIN PCB (SINGLE ZONE FRIDGES)

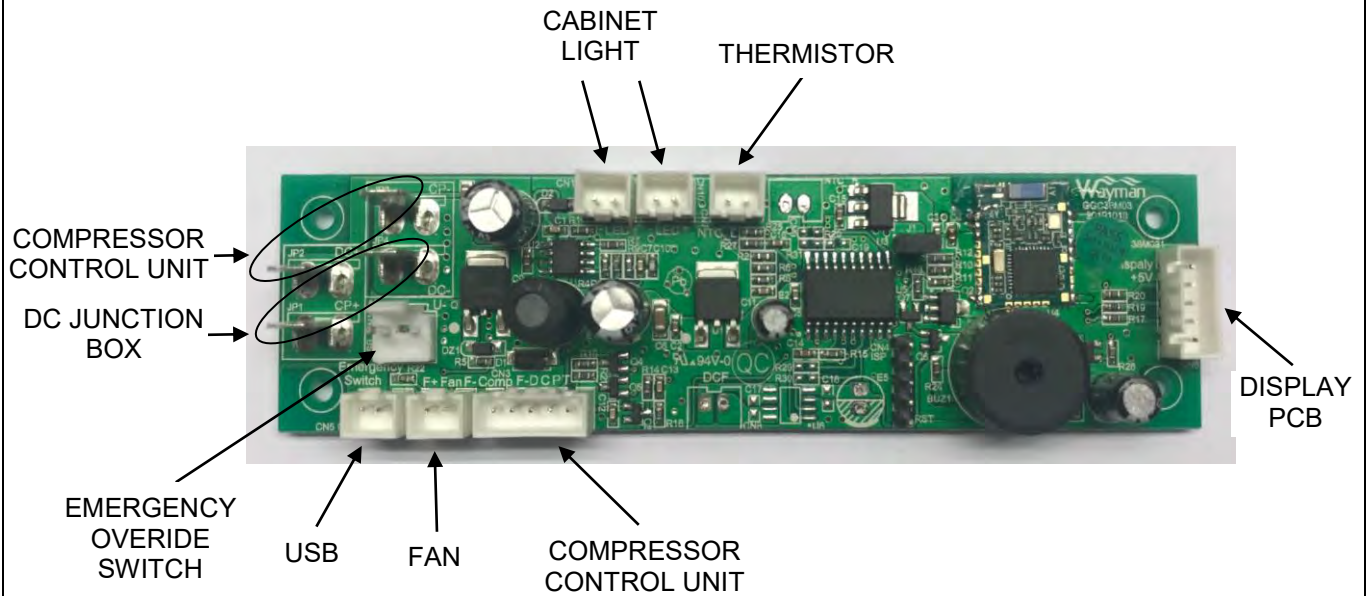

MAIN PCB (DUAL ZONE FRIDGES)

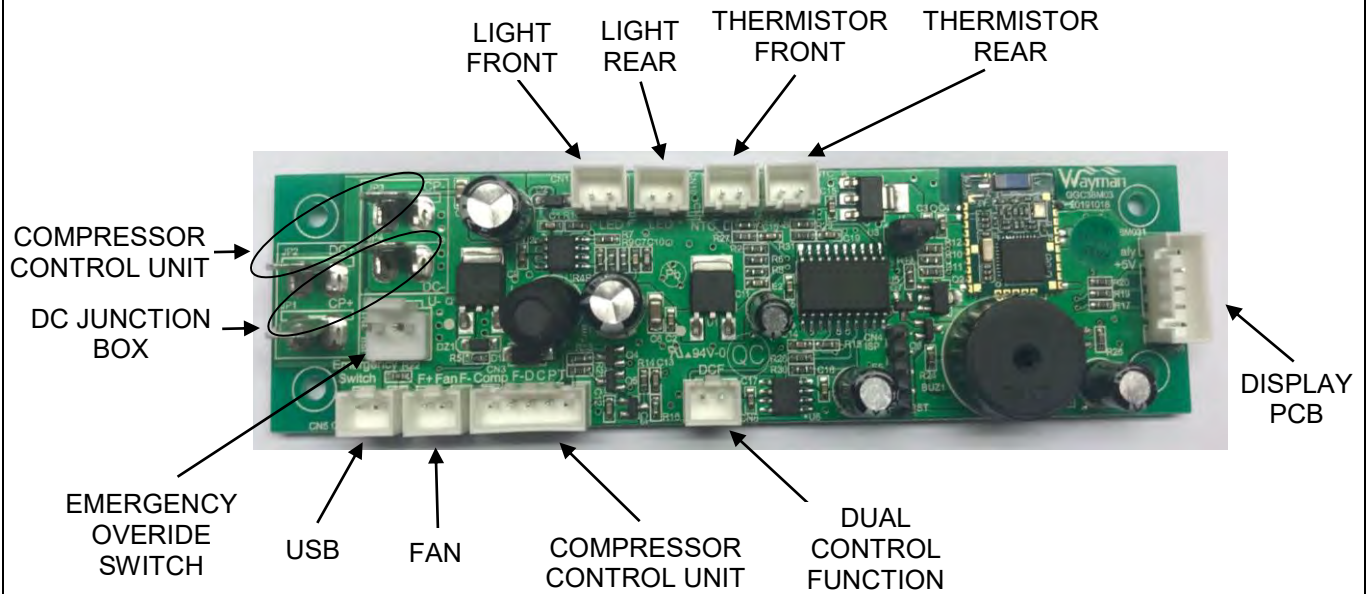

9.7 Compressor base plate – Replace



Remove the front cover as described in Section [9.3](#).

It may not be necessary to remove all circuit boards as described in Section [9.3](#).

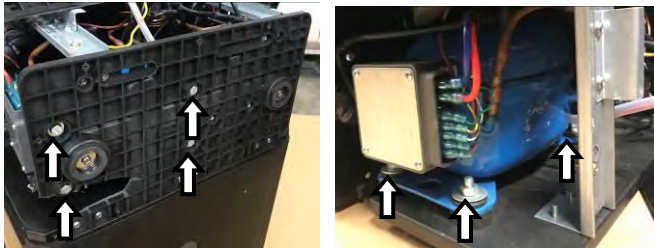

Remove the bolts securing the compressor to the base plate. To do this, you will need to hold the top securing nuts with a spanner.

It is recommended to prop the compressor while doing this as the compressor is quite heavy and will damage other components if moved.

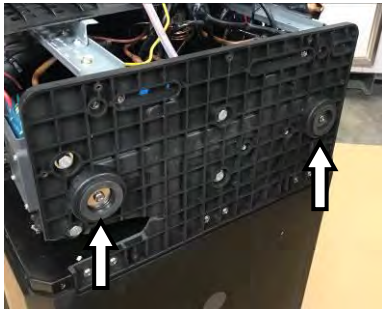

With screw driver, remove feet secured to the base.

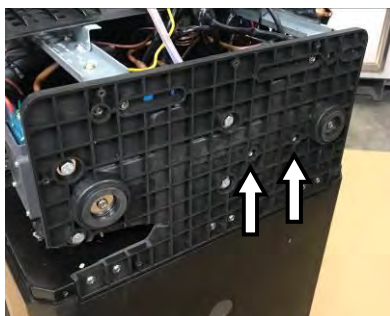

Remove the AC rectifier retaining screws.



Remove the condenser retaining screws.

Depending on the fridge model, the condenser may be secured with screws beneath the base, or above the base.

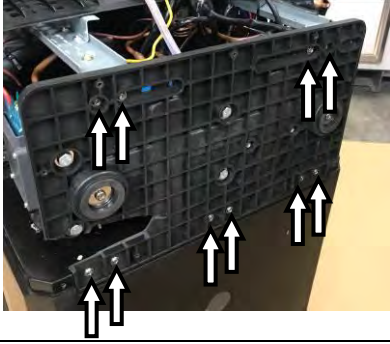

With screw driver, remove all remaining screws securing the base plate to the fridge cabinet and column.

The compressor base plate can now be removed.



To refit the new base, reverse the process as described in this section.

9.8 AC Rectifier - Replace

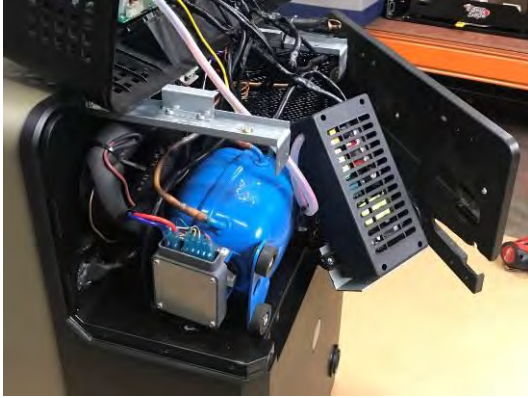

Remove the compressor base plate as described in Section [9.7](#).

Pull out the AC Rectifier assembly to gain access to the assembly.

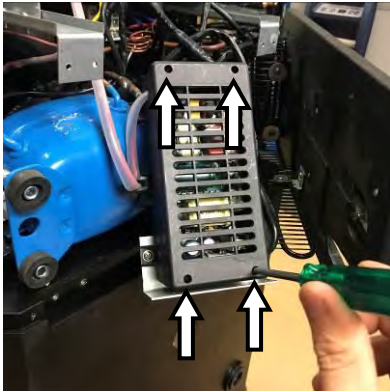

Remove the plastic cover by unscrewing the four retaining screws.

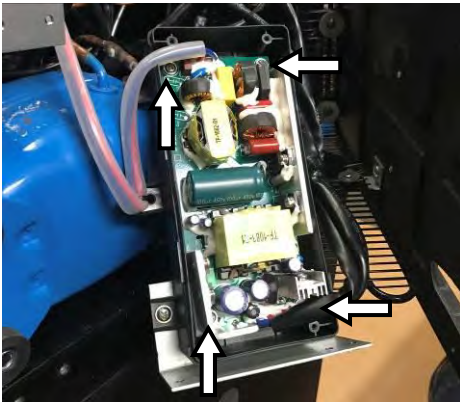

Remove the AC Rectifier PCB from the plastic housing by unscrewing the four retaining screws.

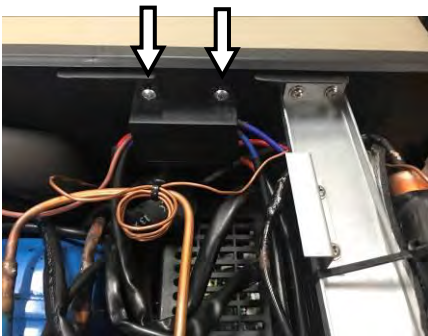

Remove junction box plastic cover by removing the retaining screws.

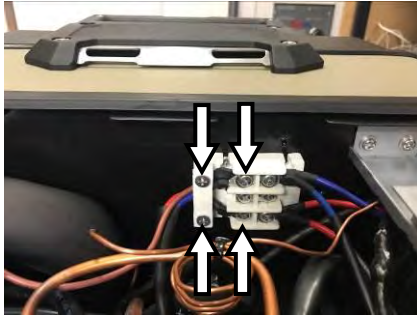

Remove the wires connected to the AC Rectifier. These screws are located to the left as shown.



Disconnect and remove the wires connected to the AC power socket.



Disconnect and remove the wires connected to the Main PCB.



The AC Rectifier can now be removed from the fridge.

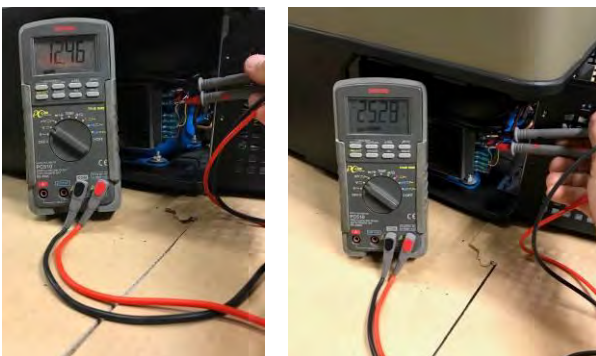

To refit the AC Rectifier, reverse the process as described in this section.

Once installed and secured safely, ensure the AC Rectifier is functioning correctly as per Section [8.2](#).

9.9 Cooling Fan - Replace

Single Zone Main Circuit Board



↑ Fan Connector

Dual Zone Main Circuit Board



↑ Fan Connector

Disconnect all power leads from the back of the fridge.

Remove the front cover as per Section [9.3](#).

Disconnect the fan connector from the main circuit board.

Connect the new fan to the main circuit board.

Connector DC power to the fridge temporarily and confirm correct operation of the fan.

HINT: Do not install the new fan until the correct operation has been confirmed.



Remove fan retaining screws that secure the fan to the condenser.

CAUTION: Take care not to stretch the refrigeration lines or power cables.



Remove fan.

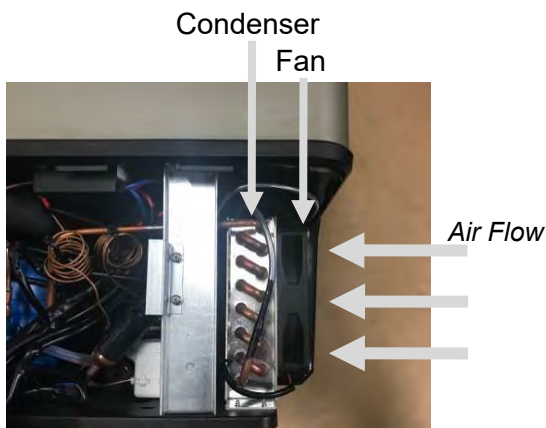

Install the new fan and fasten to the condenser using the original 4 screws.

Position the fan with the cable recess at the top as shown.

Make sure that the airflow direction marked on the fan is pointing towards the condenser.







Refit the rear cover.

CAUTION: Ensure that all cables are securely fastened away from sharp, moving or hot surfaces.

CAUTION: Make sure that all refrigeration lines are not under pressure and do not contact other parts of the fridge.

9.10 Thermistor – Replace

	<p>Disconnect all power leads from the back of the fridge.</p> <p>Remove the front cover (refer to section 9.3).</p>
	<p>Locate the thermistor cable to left hand side of fridge.</p>
	<p>Remove and retain the screw, “P”-clip and sealing compound that retain the thermistor wire.</p>
	<p>Place a mark on the thermistor wire where it exits the fridge cabinet. The new installed wire length will need to match the old wire length.</p> <p>Withdraw the thermistor wire and thermistor from the fridge cabinet.</p> <p>For dual zone fridges, there are two thermistors. The longer thermistor cable is for the rear zone and the shorter thermistor cable is for the front zone.</p>
<p>Single Zone main circuit board.</p>  <p>Thermistor</p> <p>Dual Zone main circuit board.</p>  <p>Thermistor Front Zone Thermistor Rear Zone</p>	<p>Gain access to the main circuit board as per section 9.6.</p> <p>Disconnect the 2-pin connector from the main circuit board. Remove the thermistor wire (complete with thermistor) from the fridge. Take note of the thermistor wire path.</p> <p>Insert new thermistor plug into main circuit board. Reassemble circuit board into the rear cover as per section 9.6.</p> <p>NOTE: It may be necessary to remove cable ties that have been used to secure the thermistor wire to the main wiring loom.</p>

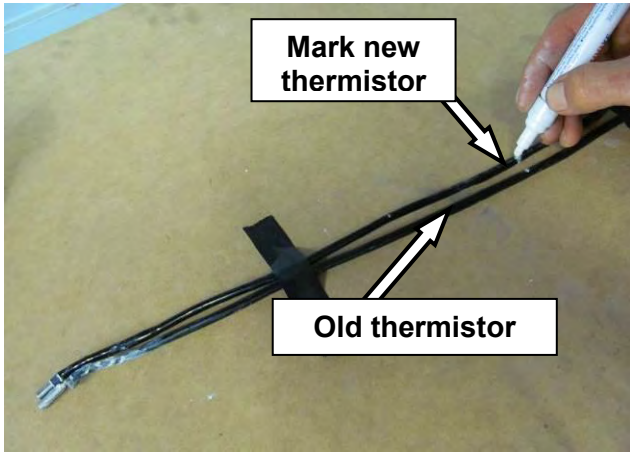

Place the old thermistor alongside the new one.
 Transpose the mark made in the previous step from the old thermistor wire onto the new one.



Apply thermal heat transfer paste to the metallic end of the thermistor as shown.
 This paste is available from Jaycar (p/n NM-2012)



Insert the new thermistor into the hole in the fridge cabinet.
 Continue to insert the thermistor wire until the mark made in the previous step lines up with the body of the fridge.



Secure the thermistor wire in place with the "P"-clip, screw and sealing compound.
 Install the new thermistor wire into the fridge using the same path as the old wire. Secure the thermistor wire main wiring loom using cable ties.
 Reassemble front cover as per section [9.3](#).

CAUTION: Ensure that all cables are securely fastened away from sharp, moving or hot surfaces.

9.11 Plug fuse (12/24V DC) - Replace

	<p>Disconnect the 12/24V DC power lead from all power supplies.</p>
	<p>Unscrew end of plug from housing.</p>
	<p>Separate plug and housing. Remove fuse from plug.</p> <p>Replace the device fuse with a new fuse of the same rating. Fuse rating DC Glass 12/24V 10Amp – 6G10A.</p> <p>Reassemble the plug and test for continuity.</p>

9.12 Device fuse (100-240V AC) - Replace

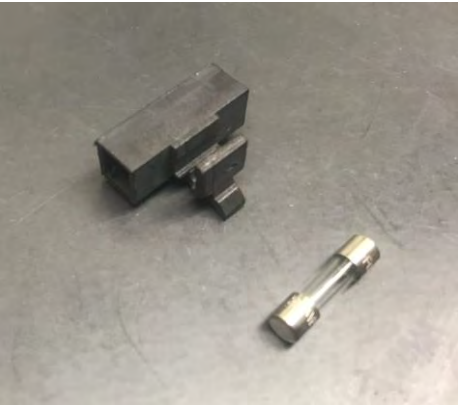
	<p>Remove the AC and DC power leads from the power sockets.</p> <p>Remove the fuse insert from the rear panel of the fridge as shown.</p> <p>HINT: A small flat blade screwdriver may be required to help pry the insert away from its housing.</p>
	<p>Replace the defective fuse with a new fuse that has the same rating. The correct rating for the fuse is 6.3A, specified as: F6.3L250V.</p> <p>Replace the fuse insert back into its housing</p>

10 SERVICE BY REFRIGERATION MECHANIC

10.1 Compressor recharge information

The ARB fridge freezer range as designated in this manual use refrigerant R134a.

Fridge Model	ZERO 36L	ZERO 44L	ZERO 60L	ZERO 69L DZ	ZERO 73L	ZERO 96L DZ	ZERO 105L
Fridge Type	10802010	10802020	10802030	10802040	10802050	10802060	10802070
Refrigerant Type	R134a						
Refrigerant Quantity	43g	45g	65g	75g	70g	96g	100g

10.2 Leaks in the refrigerant system.

If low refrigerant is suspected, the system should be pressure tested.

If the pressure test identifies a leak, the location of the leak should be found.

To locate the leak, the refrigerant system should be split into two sections (see below) and pressure tested separately.

Section 1 - All refrigerant lines and components external to the foamed cabinet. This includes the compressor and condenser.

Section 2 - The evaporator and all refrigerant lines inside the foamed cabinet.

If the refrigerant leak is located externally of the evaporator and foamed cabinet, the leak may be repaired. If the fridge is inside the warranty period a complete replacement is required.

If a refrigerant leak is detected inside the evaporator or foamed cabinet, the fridge should be replaced.

11 WIRING

11.1 Wiring diagram (Single Zone)

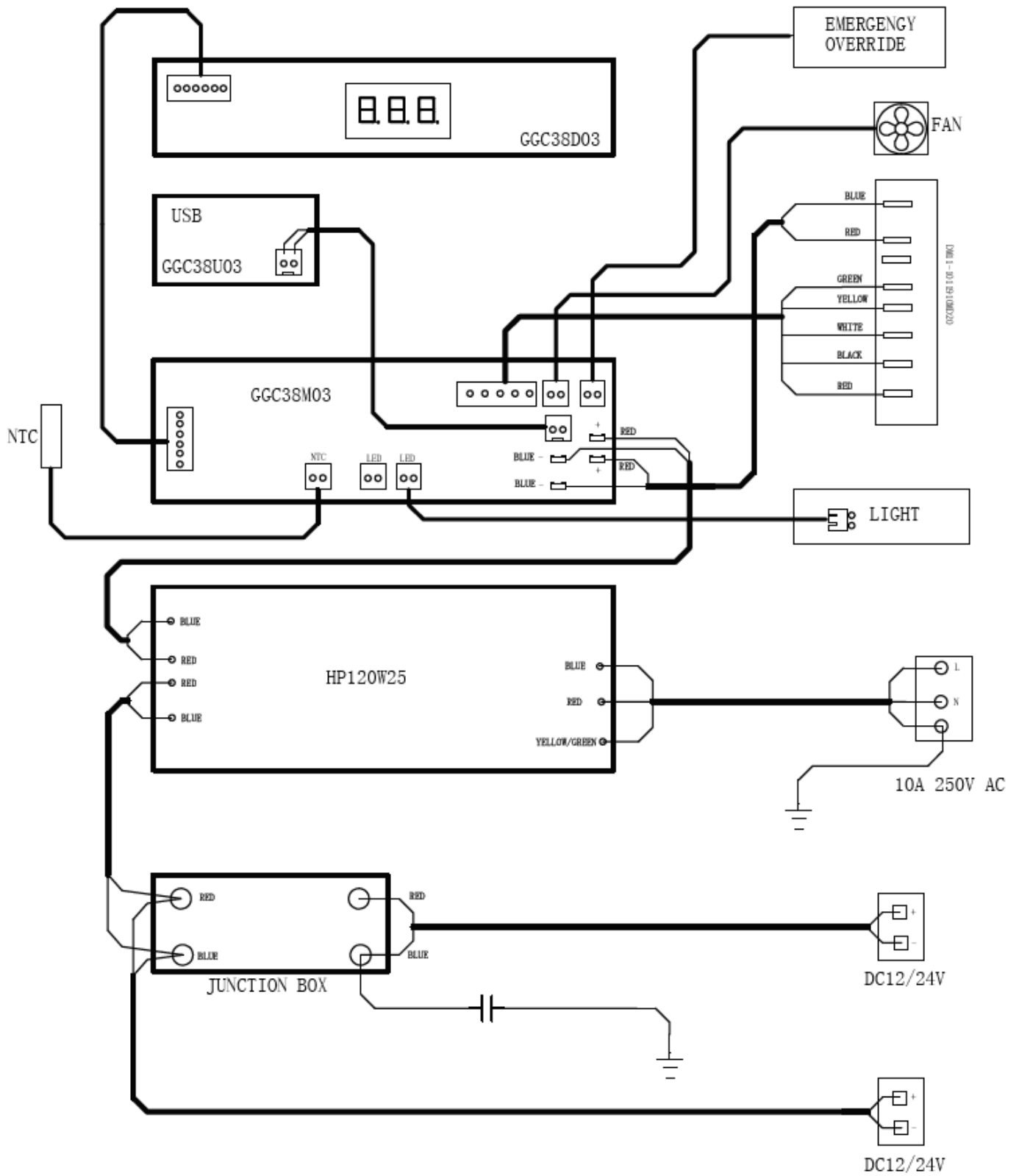

11.2 Wiring diagram (Dual Zone)

